

SPEX® SamplePrep P®

65 Liberty Street, Metuchen, NJ, 08840
1-855-GET-SPEX (438-7739) or 732-623-0465
www.spexsampleprep.com

6775 FREEZER/MILL®



OPERATING MANUAL

For 6775-115 and 6775-230 Freezer/Mills this manual is part number 87050

Copyright 2015 by SPEX® SamplePrep LLC

All rights reserved. No part of the work may be reproduced or transmitted in any form or by any means, electronic or mechanical; including photocopying and recording, except as may be expressly permitted by the 1976 Copyright Act or in writing from the publisher. Requests for permission should be addressed in writing to SPEX® SamplePrep LLC, 65 Liberty Street, Metuchen, NJ 08840.

TABLE OF CONTENTS

| SECTION | DESCRIPTION | PAGE |
|----------------|---|-------------|
| 1.0 | Introduction | 4 |
| 2.0 | Specifications | 5 |
| 3.0 | Unpacking | 6 |
| 4.0 | Setting Up..... | 7 |
| 4.1 | Electrical Connection | 8 |
| 4.2 | Power Switch and Controller..... | 8 |
| 4.3 | Lid, Coil Assembly, and LN Sensor | 9 |
| 5.0 | Touchscreen Display | 10 |
| 5.1 | Logo Screen..... | 10 |
| 5.2 | Control Panel..... | 11 |
| 5.3 | Changing Settings..... | 15 |
| 5.4 | Saved Protocols | 16 |
| 6.0 | Operation | 18 |
| 6.1 | Adding Liquid Nitrogen Coolant | 18 |
| 6.2 | Loading Samples into Freezer/Mill Vials | 19 |
| 6.3 | Loading a Vial into the Freezer/Mill | 21 |
| 6.4 | Removing a Vial from the Freezer/Mill | 21 |
| 6.5 | Opening, Emptying, and Cleaning Freezer/Mill Vials..... | 22 |
| 6.6 | Checking the Liquid Nitrogen Level | 24 |
| 7.0 | Resources | 24 |
| 7.1 | Run History..... | 25 |
| 7.2 | Accessories (Electronic Version)..... | 25 |
| 7.3 | Training..... | 27 |
| 7.4 | System Settings..... | 27 |
| 7.5 | Technical Support..... | 28 |
| 8.0 | Maintenance | 28 |
| 8.1 | Changing the Fuses..... | 29 |
| 9.0 | Trouble-Shooting Guide..... | 30 |
| 10.0 | Warranty | 31 |
| 10.1 | Product Specifications | 31 |
| 10.2 | To Arrange a Return Shipment..... | 31 |
| 11.0 | Instrument Disposal..... | 32 |
| 12.0 | Contact Us..... | 33 |

1.0 INTRODUCTION

SPEX SamplePrep Freezer/Mills are laboratory mills that cool unconventional materials to cryogenic temperatures and pulverize them to a powder form without thermal degradation. Our proven technology uses a dual electromagnetic, grinding chamber that rapidly drives a steel impactor back and forth against the two end plugs of the sample vial. Since the vial is securely closed the integrity of its contents is maintained, hazardous or critical samples are easily controlled, and cross-sample contamination is eliminated. The sample chemical composition is preserved as a result of the vials being immersed in liquid nitrogen at cryogenic temperatures throughout the grinding process. These unique aspects have made SPEX SamplePrep Freezer/Mills the most effective cryogenic mills in the world. They are the “mills of first choice” for many abnormal materials, or samples whose composition or structure cannot be ground using conventional grinding methods.

NOTE: Please do not operate the 6775 Freezer/Mill® until you have read these instructions and are familiar with its controls and operation. The Freezer/Mill is different in its principles and operation from any other laboratory mill.

OPERATING CONDITIONS: Do not set up the 6775 Freezer/Mill® in an insulated or confined space. The Freezer/Mill should be run on an open countertop, in ambient air, with recommended maximum relative room humidity 70% from 5°C - 31°C (40°F - 88°F). If the entire mill is chilled during operation, components such as the gas cylinders, controller, and display screen can fail. This damage is not covered by the Freezer/Mill warranty. During operation, water vapor in the air will condense on parts of the unit. For this reason, it is important not to place any moisture-sensitive equipment near the Freezer/Mill.

VERY IMPORTANT: Liquid nitrogen not only makes samples brittle through severe chilling, making them “grindable,” but also cools the magnetic coil which powers the 6775 Freezer/Mill. If the mill is operated without liquid nitrogen for a period of about one minute, the coil will become very warm and may sustain permanent damage. The 6775 Freezer/Mill has a liquid nitrogen sensor that should shut down the mill when the liquid nitrogen gets too low to cool the coil. Nevertheless, the nitrogen level should be visually checked during extended runs as well as topped off before every run. The Freezer/Mill warranty does not cover damage to the coil caused by operating the mill with little or no liquid nitrogen.

SAFETY: Liquid nitrogen (LN) can be hazardous. Its boiling point is -195.8°C (-320.4°F). When working with liquid nitrogen directly or indirectly, the LN Tank valve or hose, or chilled Freezer/Mill components, cryogenic gloves must be worn to protect hands. A face Shield is also recommended to protect eyes from possible splashing. Be careful not to splash liquid nitrogen onto clothes or unprotected skin. Wear the proper protection equipment (PPE). Make sure that all users of the 6775 are trained in the usage and handling of liquid nitrogen. Additional information on LN safety can be found at <http://engineering.dartmouth.edu/microengineering/ln2.html>.

2.0 6775 FREEZER/MILL SPECIFICATIONS

| | |
|---|---|
| Type of Mill: | Cryogenic impact mill |
| Controller: | Touchscreen |
| Data Transfer: | USB Port (back of controller) |
| Grinding Mechanism: | Steel impactor driven by dual electromagnets |
| Coolant: | Liquid nitrogen (LN) |
| Dimensions: | 19 in. (48 cm) long x 10½ in. (27 cm) wide x 12-¾ in. (32 cm) high. |
| Weight: | 18.9 lbs. (8.6 Kg) |
| Grinding Vials: | One 6751, 6761, 6771, 6781S, or One 6757 Microvial Set. |
| Typical Vial Capacity: | 6751 Vial Set: actual volume with impactor, approx. 25 ml. |
| Typical Sample Weights: | 2 grams for biological samples, 1 gram for polymers. The maximum capacity for easily ground samples of moderate density is approximately 8 grams. Overfilling a vial greatly reduces its efficiency. 6757 Vial Set: 100 - 500 mg per individual 6757 Microvial, depending on sample. <i>Effective capacity for a given sample may be smaller or larger than those given, depending on sample properties such as physical form, density, flexibility, etc.</i> |
| Typical Liquid Nitrogen Consumption: | 4-5 liters for initial cool-down and filling of the tub. 3-6 liters for each hour of operation. Actual LN consumption can vary. |
| Cryogenic Dewar | A 5L to 10L Dewar is recommended for manually filling the tub. For a larger capacity Dewar (25L) see Section 8.0 of manual, part 6905. |
| Electrical Specifications: | CE Approved. Available as 115V/60HZ or 230/50HZ. |
| Fuses: | Two 5-amp slow-blow fuses in AC Input module. 25-amp slow-blow fuse on driver board. |
| Power Cord: | 115V/60HZ version: 3-prong grounded plug supplied. 230V/50HZ version: 2-prong European plug supplied. <i>Operator is responsible for supplying alternate line cord/plug. (If necessary)</i> |
| Safety Features: | Lid Interlock prevents mill from running if lid is not latched shut. Liquid nitrogen sensor shuts down mill if LN level is too low. |
| <u>NOTE:</u> | <i>The sensor can shut down the mill during a run, so the liquid nitrogen level should be visually checked during extended runs as well as before every run. The Freezer/Mill warranty does not cover damage to the coil caused by operating the mill with little or no liquid nitrogen.</i> |

3.0 UNPACKING

Inspect the exterior of the packing box and report any visible damage to the carrier. Remove all packing documents from the exterior of the box, and save them for your records. Open the top of the shipping box. Remove the packing material and accessories, and gently remove the 6775 Freezer/Mill. Visually check the mill for any damage that may have occurred during shipping. Unlatch the lid and inspect the interior of the tub, ensuring that it is free of any packing material. Check the packing list to see that there are no parts missing, and inspect the accessories. We recommend storing the packaging materials in the event there is a need to return the unit for warranty service or repairs.

Grinding vials are necessary for processing samples but must be purchased separately. The full range of grinding vials and accessories for the 6775 Freezer/Mill is described in our catalog, The Handbook of Sample Preparation and Handling, and at www.spexsampleprep.com.

Inspect the accessories. Check the packing list to see that there are no parts missing. If everything seems to be in proper order, store the packaging materials, in case there is a need to return items.

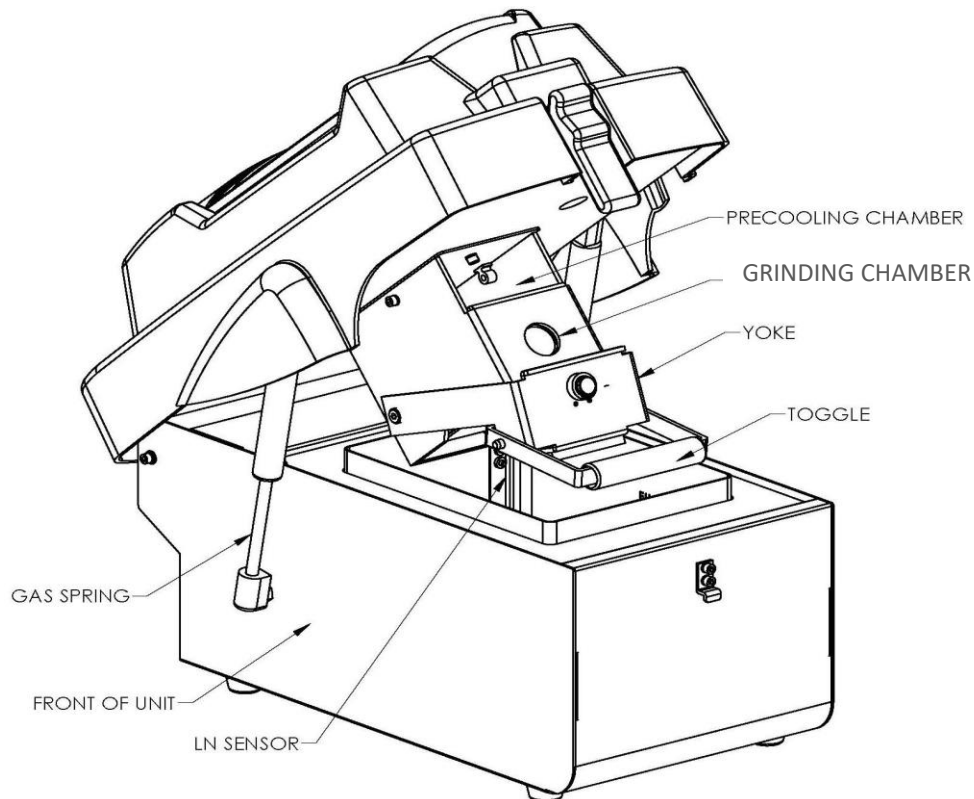

Figure 1 - 6775 Freezer/Mill, Front View

3.0 UNPACKING (Cont'd)

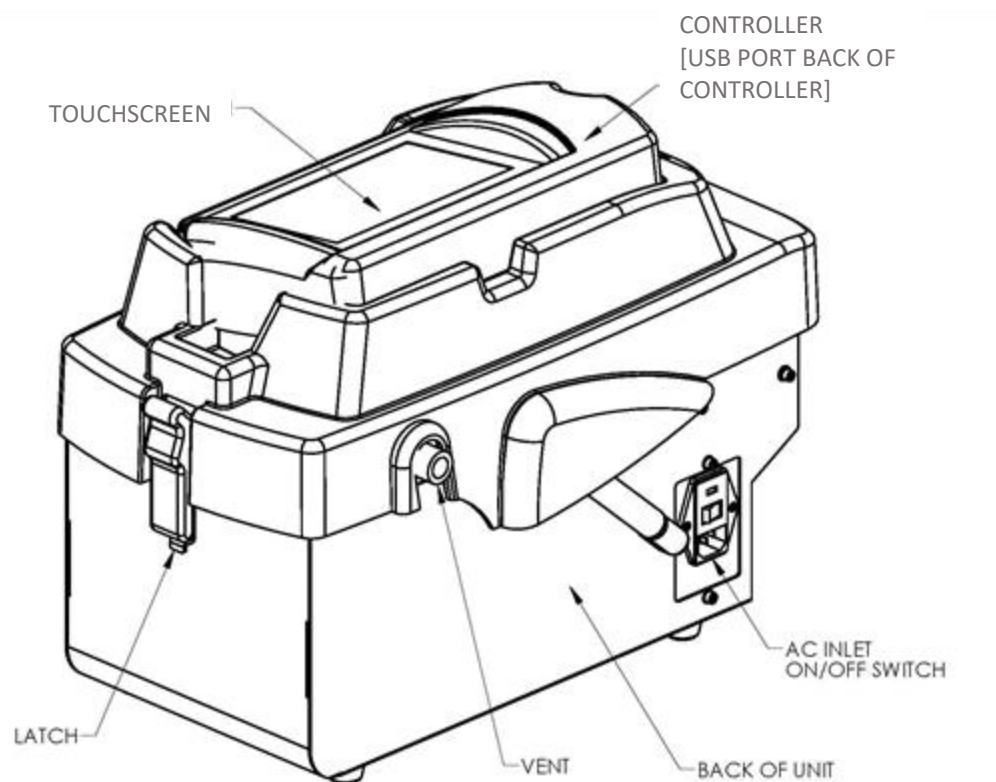

Figure 2 - 6775 Freezer/Mill, Rear View

4.0 SETTING UP

The 6775 Freezer/Mill weighs 18.9 pounds (8.6 Kg) empty. The lid is hinged on the left side of the cabinet and opens from the right; the lid latch is on the right. The AC Input module is on the back of the cabinet, and includes the power switch and fuse tray. The fuse tray can be opened with small screwdriver or knife-blade. Also on the back of the cabinet is the vent from the liquid nitrogen tub. There are gas cylinders on the front and back of the mill, to control the movement of the lid. The controller is affixed to the top of the lid and linked to the unit by a RJ45 Ethernet cable connector. At the back of the controller is an USB Port to upload and download data, or to upgrade software.

4.1 Electrical Connection

Plug the electrical cord into the inlet on the back of the Freezer/Mill cabinet, and then into a standard 3-prong grounded electrical outlet. A fused 20-amp circuit is recommended for the 115V/60 HZ version. The 230V/50HZ, 6775 Freezer/Mill is supplied with a standard European 2-prong plug with cord. For the 230V/50HZ version, make sure the cord and plug conform to local electrical codes.

The fuses are next to the electrical cord inlet in the Fuse Holder. To replace a fuse, first remove the electrical cord from the inlet. Use a small screwdriver to pry open the fuse panel. There are two individual fuse holders, each with a protruding tab. Push the tab sideways to pop out the fuse holder allowing the holder to be removed with the fingers. ***Never use pliers or force to remove a fuse holder.*** Both fuses must be replaced. (Section 8.1)

4.2 Power Switch and Controller

Electric power to the Freezer/Mill is controlled by a rocker switch on the inlet module. It is marked with two numerical symbols (0 for OFF and I for ON). Press the “I” side of the switch to turn the power ON, or press the “0” side of the switch to turn the power OFF. When power to the mill is turned ON, the controller display will light up.

The controller screen is a touchscreen that can be activated by a fingertip or stylus. Data is transferred to other computer devices via USB Port, located in back of the controller. The 6775 Freezer/Mill has one grinding chamber, which is programmed on the Control Panel screen (Section 5.2). The programmable parameters include Cycles (number of grinding periods), Precool Time (initial chilling of sample), Run Time (grinding period), Cool Time (time between grinding periods), and Rate (speed of the impactor in cycles per second). The Control Panel also displays a warning if the lid is not fully closed, or if there is not enough liquid nitrogen in the tub.

The viewing angle of the controller on the 6775 Freezer/Mill can be adjusted to minimize glare. To adjust the viewing angle, simply grasp the back of the controller box and gently pull forward until the desired angle is reached, as shown in Figure 3. If it is necessary to send the unit back to SPEX SamplePrep for service, be sure to return the controller to its horizontal position before packing the unit for shipping.

4.2 Power Switch and Controller (Cont'd)

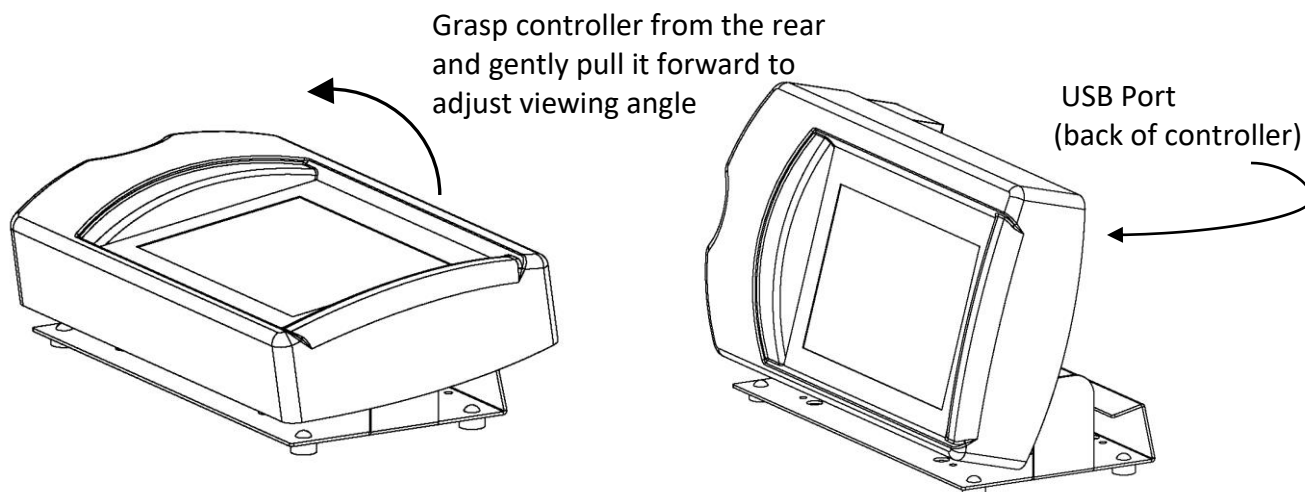

Figure 3 - Adjusting the Viewing Angle of the Controller



4.3 Lid, Coil Assembly, and LN Sensor

The lid of the Freezer/Mill supports the coil (dual electromagnet assembly) and coil housing. To open the lid, hold the lid down with one hand, and with the other push the upper end of the latch to the right. The lower end of the latch should disengage from the cabinet. Raise the lid, whose movement is damped by two gas cylinders. These also keep the lid raised when open. The lid must be open to insert vials into the chamber or to remove them and to add liquid nitrogen. A vial is inserted into the circular hole on the right side of the coil housing. The rectangular space at the top of the chamber is for precooling one to three loaded vials. **Do not run the 6775 Freezer/Mill without a loaded vial in the chamber.**

The yoke (6775 Front View, Figure 1) holds the vial in the chamber during grinding. When the lid is closed, the yoke automatically shuts and the yoke toggle rides up the inside of the tub. When the lid is raised, the yoke will usually drop so a vial can be removed or inserted. If the yoke stays up, pull the toggle out and down. **(Always wear cryo-gloves when touching a chilled vial or any part of the chilled chamber housing!)** When shutting the lid, push it down gently, and the yoke will close. Never force the lid down strongly against resistance in case the yoke gate is jammed.

The lid must be shut and latched for the Freezer/Mill to run. Push the lid down with one hand, and hold it down while engaging and closing the latch.

4.3 Lid, Coil Assembly, and LN Sensor (Cont'd)

The liquid nitrogen (LN) sensor is the small tube mounted on the left wall of the LN tub. If there is not enough liquid nitrogen in the tub to start the mill when the  button is touched the **LN LEVEL LOW** screen (Section 5.4) will display LN LEVEL LOW. If the LN runs low during a grinding program the same message will appear and the program will stop. To continue running, fill the tub with liquid nitrogen to the mark on the back of the tub. When the  button is pressed, the grinding program will begin where it left off.

5.0 TOUCHSCREEN DISPLAY

The 6775 Freezer/Mill is programmed and operated through a series of touchscreen displays. Transition between screens, and all programming and operating commands, are done by touching the screen with a fingertip or stylus. **Do not use a sharp point as this can damage or deface the screen.**

5.1 Logo Screen

When the power is switched ON at the back of the mill, “Please wait” appears during start-up as the software loads. Then the SPEX SamplePrep logo is displayed, web address and a brief animated representation of the Freezer/Mill. After the animation has finished, the screen will switch to the **Home Screen**, as shown in Figure 4. From the Home Screen the Control Panel, Saved Protocols, and Resources (Run History, Tech Support, Accessories, Training material) can be accessed by touching the buttons displayed.

The Home Screen  Icon can be found on the following screens (e.g. Control Panel, Resources, Saved Protocols) positioned at the bottom right of the screen. Touching the Home Icon allows the users to return to the Home Screen.



Figure 4 – Home Screen

5.2 Control Panel

NOTE: To keep a run from being interrupted by the liquid nitrogen (LN) sensor, the LN level should be visually checked from time to time during extended runs, as well as before every run.

The Control Panel displays the programmed run parameters, as shown in Figure 5. Changes to the run settings, are made from this screen. The 6775 Freezer/Mill is **Only** equipped with one Grinding Chamber.

To recall stored run protocols, touch the  button located at the bottom right of the screen. (See section 5.4 for more information on Saved Protocols)

--To return to the Home Screen touch the Home Icon. 

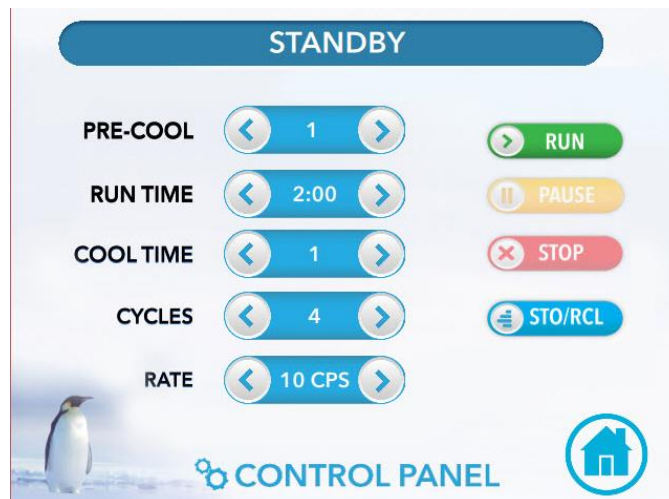

Figure 5 – Control Panel Screen

The following sequence of events will occur from the current settings in Figure 5

1. Precool - the coil is inactive while the vial cools in liquid nitrogen for 1 minute. Samples must be precooled before grinding (10 minutes is recommended).
2. Cycle 1 - the coil is activated and the impactor grinds for 2 minutes at a rate of 10 cycles per second (20 impacts per second).
3. Cool Time - the coil is inactive for 1 minute allowing coil and sample vial to cool down.
4. Cycle 2 - the coil is activated and the sample is ground for another 2 minutes.
5. Cool Time - the coil is inactive for 1 minute, as in step 3.
6. Cycle 3 - the coil is activated and the sample is ground for another 2 minutes.
7. Cool Time - the coil is inactive for 1 minute, as in step 5.
8. Cycle 4 – the coil is activated for the final 2 minute cycle. At the end of the final cycle the program is complete and the sample has been ground for a total of 8 minutes.

5.2 Control Panel (Cont'd)

On the **CONTROL PANEL**, The STATUS BAR (top of screen) counts down the Time Remaining for a run. Before a run starts, the STATUS BAR will display STANDBY, as shown in Figure 5.

To change the settings of a selected field, press the arrow buttons on the **CONTROL PANEL** screen. The left arrow buttons decrease the number displayed and the right arrow buttons increase the number displayed.

5.2.1 Starting a Programmed Run

To run the program displayed on the **CONTROL PANEL** screen, touch  button. The Freezer/Mill can be started, stopped, or paused in the middle of a grinding program from the button selections to the right of the screen.

Open the lid and place the loaded sample vial in Chamber Opening, then **SLOWLY** close the lid to keep the liquid nitrogen from splashing or spilling out the tub. Two additional loaded sample vials can be placed in the precooling chamber while running sample (Figure 1). By precooling the additional loaded sample vials, the PRECOOL time for these samples can be decreased or eliminated during the next run. After all vials have been loaded, lower the lid and secure the latch. If the liquid nitrogen in the tub is not at the correct operating level, then the screen will display LN LEVEL LOW (Figure 6). Add more LN and touch RESUME to begin operation.



Figure 6 – LN Level Low Screen

If the lid is not completely closed and latched, the screen will display LID OPEN, as shown in Figure 7. To abort the program, touch the  button. To continue with the program touch the RESUME button after the lid has been completely closed. When the tub is filled with liquid nitrogen to the correct level, and the lid is securely latched, the STATUS BAR will turn **green** and begin counting down. The PRECOOL sequence will start indicating the beginning of the grinding program.

5.2 Control Panel (Cont'd)

Figure 7 – Lid Open Screen

During the PRECOOL stage the TIME REMAINING line counts down the time for that stage in 1-second increments. To pause the program, touch the **PAUSE** button. To continue the program, touch the RESUME button. To abort the program, touch the **STOP** button. To start a new program, touch the **RUN** button. When a programmed stage (e.g. PRECOOL) is complete a **green check mark** will appear next to that field. (Samples must be precooled)

Following the PRECOOL stage is the first GRINDING cycle stage. The RUN TIME line will display the time remaining in that cycle of the grinding stage. At the end of each grinding period a **green check mark** is placed next to that field. If there are 4 total grinding periods, the CYCLES line will countdown to "0".

NOTE: Touching and holding the Run screen, during a programmed run displays the current run settings in an **orange color font**.

The protocol description located bottom of screen will change to **SETTINGS**.



Figure 8 – Run Screen during grinding

5.2 Control Panel (Cont'd)

As shown in Figure 8, the RUN TIME line indicates the 2 minute grinding period has been completed for the 1st grinding Cycle out of 4 grinding Cycles. Between any two grinding periods is the COOL DOWN stage. The COOL TIME line displays the time remaining in the COOL DOWN stage. The Cool Time for 1 minute is set to start as indicated by the yellow symbol. At the end of each Cool Time period a **green check mark** is placed next to that field. The Rate is 10 cps (cycles per second).

The STATUS BAR (top of screen) counts down the Time Remaining for the programmed run. The Time Remaining to complete the programmed run is 11 minutes and 58 seconds, as displayed in Figure 8. The bottom of the screen displays the Protocol Name for the run. If no Protocol Name is assigned to the run as a Saved Protocol (Section 5.4) then the default name will be displayed as COUNTDOWN. When the grinding program has ended, the screen will display RUN COMPLETE (Figure 9). Touchscreen to return to the Control Panel.

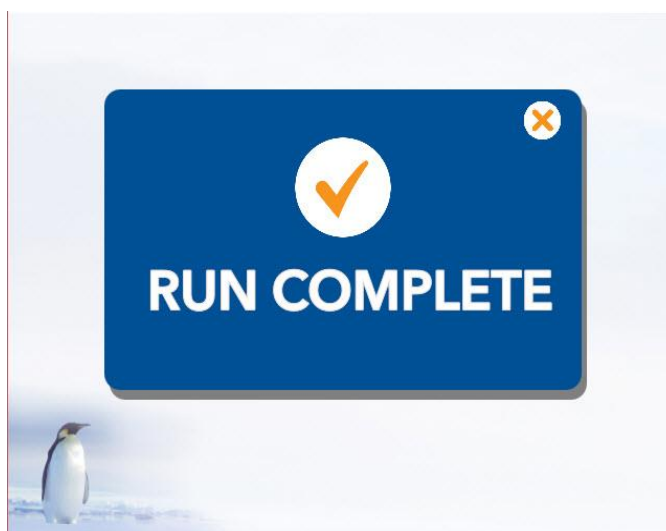



Figure 9 – Run Complete Screen

5.2.2 Adjusting the Grinding Rate

While in the **CONTROL PANEL** screen, the only parameter that can be modified during grinding is the RATE. It is adjusted by touching the right and left arrow buttons next to the Rate field. Touching the right arrow increases the rate by 1 cps at a time, while touching the left arrow decreases the rate by 1 cps. Tap or hold the right or left arrow buttons until the desired rate is reached.

Rate is the number of back-and-forth cycles per second (cps) completed by the impactor. During one cycle the impactor strikes both end plugs of the vial, therefore a rate of 10 cps is equivalent to 20 impacts per second. The factory default setting for the rate is 10 cps. The maximum grinding rate is 15 cps and the minimum is 5 cps.

5.2.3 Stopping or Pausing a Run

To stop a program, touch the  button on the **CONTROL PANEL** screen and the program will end. If the  button is touched after the program has stopped then the entire program will start over.

To pause during a grinding program, touch the  button. The **RUN** will hold the settings at that moment (elapsed time, cycle, etc.). To resume the program, touch the Resume button. This will restart the program at the point at which it was paused. Alternatively, pressing STOP will end the program.

5.3 Changing Settings

To change parameters (precool time, grinding time, cool down time, cycles and rate), touch the arrow buttons on the **CONTROL PANEL** screen. The changes will appear in the blue area between the arrows, as shown in Figure 10.

The CONTROL PANEL allows the user to change the parameters by touching the right and left arrows next to the field. Touching the right arrow increases the parameter, while touching the left arrow decreases the parameter. Tap or hold the right or left arrow buttons until the desired number is reached. The arrow key will turn blue when the maximum or minimum number is exceeded. To run a program with the new settings, touch the  button.

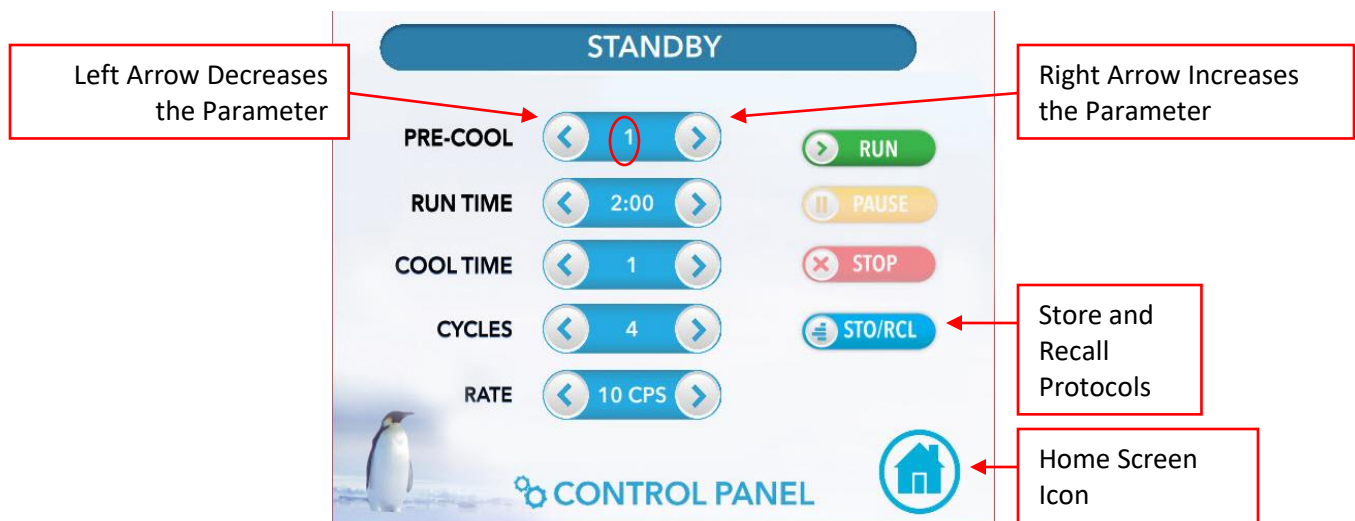

Figure 10 – Changing Settings

5.4 Saved Protocols

The **SAVED PROTOCOLS** screen is shown in Figure 11. In this example, three saved protocols have been stored and named (e.g. Hair, Bone, Soft Tissue). Up to 20 Protocols can be stored. Only 10 protocols at one-time are visible on the Saved Protocols screen. To access or make visible additional protocols, or vacant protocol spaces (e.g. User Protocol) swipe up or down the touchscreen. This brings up vacant protocol slots on the **SAVED PROTOCOLS** screen.

A saved program retains the settings for number of cycles, precool time, run time, and cool time between cycles. Be sure to adjust the rate to the desired setting after recalling a stored program.

The Default protocol recalls the last programmed run setting that was not saved. The Default protocol can be changed without saving the new settings, as described in section 5.4.

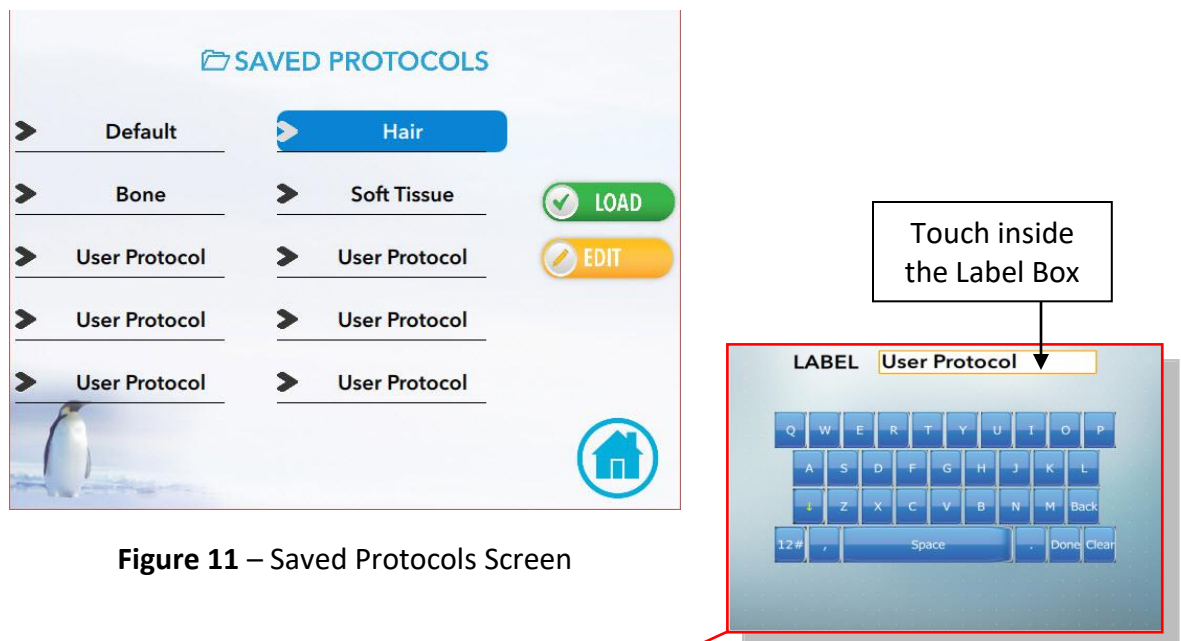

Figure 11 – Saved Protocols Screen

5.4.1 Storing a new program

To store the new program or to recall a stored program, touch the **STO/RCL** button on the Control Panel screen (Figure 5). In the **SAVED PROTOCOLS** screen, touch inside the Label Box, as shown in Figure 12.

This will bring up the **KEYBOARD** screen, a simplified version of the standard keyboard for a computer. In addition to number and letter keys, this keyboard has standard symbol keys (#, %) and four function keys (SPACE, BACK, DONE, and CLEAR).

As the letters/numbers are touched, they appear above the keyboard in the Label Box with a centered cursor. To access the number and symbol keys touch the 12# button located bottom left on the **KEYBOARD** screen. To switch back to letter keys touch the ABC button (same button) bottom left on the **KEYBOARD** screen.

5.4 Saved Protocols (Cont'd)

The Up/Down yellow arrow key allows the user to shift back and forth from upper case to lower case (the default is upper case). Touch Down arrow to switch to lower case. Or touch Up arrow to revert to upper case.

Touching the SPACE key advances the cursor one space. Touching the BACK key deletes one space. The CLEAR key deletes whatever has been entered in the Label Box.

Touch the SAVE button to save the label shown in the Label Box. The label will appear as the name of the program in the **SAVED PROTOCOLS** screen (Figure 11).

The CANCEL key does not change anything on the screen, but returns the display to the **SAVED PROTOCOLS** screen.

To run the newly saved protocol, touch the protocol to highlight (BLUE) the name. Then touch the LOAD button to send protocol to the **CONTROL PANEL** screen. Review the parameters and touch the  button to initiate the protocol.

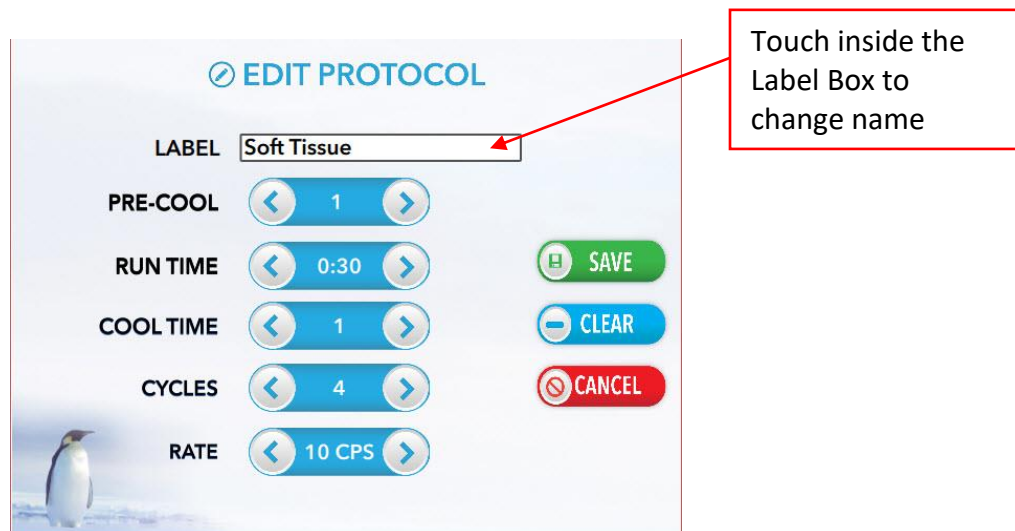

Figure 12 – Edit Protocol Screen

5.4.2 Delete Protocol

To delete a saved protocol, touch the protocol to highlight (BLUE) the name. Then touch the EDIT button. From the Edit Protocol screen touch the CLEAR button. A pop-up window opens confirming to delete this protocol, as displayed in Figure 13. Touch YES to clear or touch NO to keep the saved protocol. To rescind this action touch CANCEL button. To retain the action touch the SAVE button. Saving the clear protocol returns the parameters to the default setting (i.e. User Protocol).

5.4 Saved Protocols (Cont'd)



Figure 13 – Clear Protocol Screen

5.4.3 Edit Saved Protocols

To edit a saved protocol, touch the protocol to highlight the name (BLUE). Then touch the EDIT button. From the Edit Protocol screen change parameters and/or name, then touch the DONE button.

5.4.4 Recalling a program

In the **SAVED PROTOCOLS** screen, touch the protocol to highlight the name (BLUE). Then touch the LOAD button to send protocol to the **CONTROL PANEL** screen. Review the parameters. To RUN the protocol touch the  RUN button to initiate the protocol.

6.0 OPERATION

6.1 Adding Liquid Nitrogen Coolant

Liquid nitrogen is manually added to the 6775 Freezer/Mill using a portable Cryogenic Dewar. Fill a 5L or 10L Dewar with LN, open the lid and pour LN in the tub. For a larger capacity Dewar (25L) see Section 8.0 of manual, part 6905. The 6775 should be filled until the LN level reaches approximately 2 inches (5.1 cm) below the lip of the tub. If the liquid nitrogen is above this level when the lid is closed, LN can splash outside the tub or exit the vent on the back of the unit.

Always close the lid slowly to avoid splashing.

Liquid nitrogen will most likely be available either in a large tank with a flexible steel hose, or in smaller Dewar flasks. The 6775 Freezer/Mill typically consumes 4 to 5 liters of LN during initial cool-down, and another 3 to 6 liters per hour, depending on use.

6.1 Adding Liquid Nitrogen Coolant (Cont'd)

Unlatch the lid and the gas cylinders will push it open. To unlock the latch, press down on the lid and push the top of the latch to the right and down. Disengage the bottom of the latch and the lid will open. The chamber assembly is attached to the lid and will rise with it. If there is no vial in the chamber, the yoke will drop open when the lid is lifted. If the yoke remains closed, pull the toggle outward to lever the yoke open.

When the Freezer/Mill tub is empty, pour liquid nitrogen (LN) into the tub until it is approximately one third full. Initially LN will boil off vigorously, but as the tub cools the boiling will subside. Add more LN gradually, to avoid splashing and boiling over. When the LN is up to the fill mark and boiling has subsided, push the lid down gently until the bottom of the latch can be engaged. Pause if splashing becomes excessive. When the vapor stream has subsided, lift the lid again and top off the liquid nitrogen in the tub, filling it to the mark on the inside wall of the tub. Insert a loaded vial into the chamber. One to three additional vials can also be put in the precooling chamber above the grinding chamber at this time.

Press the Freezer/Mill lid closed and latch it. When the lid is closed and latched, further nitrogen boiling will be visible as a stream of condensed water vapor ("fog") from the vent in the rear of the Freezer/Mill; this is normal. A grinding program can now be run, as outlined in Section 5.2.

6.2 Loading Samples into Freezer/Mill Vials

6.2.1 Introduction and General Recommendations

Start by choosing a sample that is typical of those to be ground on a regular basis. For a polymer, measure out 1-2 g; for bone or tissue samples (plant or animal), 2-5 g. In practice, the various parameters (sample weight and size, precooling time, grinding times and cycles, etc.) are customized to match particular samples. As a rule of thumb, the sample pieces should be small enough to circulate inside the vial as the impactor moves back and forth, and should take up no more than $\frac{1}{3}$ to $\frac{1}{2}$ the volume of the vial, with the impactor in the vial. Avoid overfilling vials as this greatly reduces grinding efficiency.

In practice, the optimum parameters (sample weight and size, precooling time, grinding times and number of cycles, impactor rate, etc.) are customized to match particular samples.

Procedures for specific materials should be determined by trials; in practice almost no two materials grind alike.

If at first the sample doesn't grind as intended, try these strategies:

- Reduce the overall weight of the sample. (Some fibers and thin films may grind best with a sample weight of 100-200 mg.)
- Reduce the size of the individual pieces to $\frac{1}{4}$ or $\frac{1}{8}$ inch (see 6.2.2 below).

6.2 Loading Samples into Freezer/Mill Vials (Cont'd)

- Increase the precooling time. (20 minutes of precooling is about the maximum necessary for most samples to reach LN temperatures.)
- Grind longer. (20 minutes of actual grinding time is the maximum recommended for one run, due to the LN capacity of the tub, but the tub can be refilled and the run repeated if necessary.)

Table 1 - Typical Sample Sizes

| Sample | Small Vial 6751, 6761, 6771, 6781S | Microvial 6757 |
|-------------------------------------|---------------------------------------|-------------------|
| Plant tissue, bone, muscle, etc. | 2-5 g | 100-300 mg |
| Polymer pellet | 1-2 g | 50-100 mg |

CAUTION: When handling chilled samples or vials, or touching parts of the Freezer/Mill that have been chilled by LN, always wear protective gloves.

6.2.2 Size of Sample Pieces

The size of sample pieces is important. For uniform results, most samples should be cut into pieces smaller than ¼ inch (6 mm). Very tough samples such as fresh bone should be cut smaller, down to ⅛ inch (3 mm). There are several reasons for this:

- The more irregular the size of the sample pieces, the more difficult it is to predict the results. Uniform procedures work better with uniform samples.
- Thin fibers and films can be very difficult to cryogrind unless they are cut into small pieces first. Wads of long fibers and crumpled balls of film take up extra room and can be elastic, even at LN temperatures.
- Tough samples in large pieces can be very difficult to grind, and in rare cases may damage the vial. A large, wedge-shaped piece of bone or a tough polymer can act as a wedge to push a moving impactor through the side of the polycarbonate tube.

6.2.3 Loading a Sample into a Vial at Room Temperature

Most Freezer/Mill samples do not have to be kept cold all the time and can be loaded at room temperature. To load a vial, first assemble it halfway by pushing a blunt end plug into a center cylinder. Add the sample and impactor to the vial, and close it with the flanged end plug. Shake the vial to make sure the impactor has room to move back and forth.

6.2.4 Loading a Cold Sample into a Vial and Keeping it Cold

Some samples must be kept cold, such as plant or animal tissue being prepared for RNA extraction. When a sample is cold, and must be kept cold throughout the grinding process, the loading procedure is more elaborate.

Assemble the center cylinder and blunt end plug, as in 6.2.3, then chill the end plug and about an inch of the cylinder in a shallow liquid nitrogen bath. The vial rack that comes with the 6775 Freezer/Mill can be placed in an insulated container and used to hold the vials upright during chilling. At the same time, chill an impactor separately. As soon as the submerged end of the vial is chilled, drop in the cold sample and then the chilled impactor. ***(Always wear insulated gloves when handling chilled vial components directly!)*** Now carefully insert the other end-plug, still warm, into the warm end of the cylinder. The vial can now be carefully placed in the mill, or submerged in a liquid nitrogen bath outside the mill, as long as care is taken not to let the sample touch the warm end plug before it has cooled down.

CAUTION: Never force an end plug (warm or cold) into a polycarbonate cylinder (warm or cold). Polycarbonate shrinks when chilled, and can crack if stressed. If the cylinder has cooled to the point that the end plug fit is too tight, allow the cylinder to warm up before inserting the end plug.

6.2.5 Loading a Very Small Sample into a Vial and Keeping it Cold

A variant of the loading technique in Section 6.2.4 can be used to grind very small samples with the open pre-chilled vial upright. Place the sample on the chilled end plug and add a small amount of fluid such as an extraction medium or water. The frozen fluid will bulk up the sample enough so it will circulate in the vial during grinding. To speed up this process, some users first prepare small “ice cubes” of the sample frozen together with 0.5 ml to 1 ml of fluid.

6.3 Loading a Vial into the Freezer/Mill

Before loading the vial in the mill, put on cryogenic gloves. Unlatch and lift the lid of the mill, and the yoke should open. Pick up the vial with a gloved hand and insert the vial into the chamber, blunt end first. Additional vials can be precooled by inserting them into the precooling chamber in the coil housing (see Figure 1). Check the liquid nitrogen (LN) level and top it off if necessary. Gently close the Freezer/Mill lid. The yoke will shut automatically, and the handle will retract into the tub. (If the lid resists closing, make sure the vial is inserted all the way in the chamber.) Latch the lid shut.

6.4 Removing a Vial from the Freezer/Mill

At the conclusion of the grinding cycle, unlatch the lid and let the gas cylinders lift it. Do not force the lid, but allow it to rise at its own speed. If the yoke does not open by itself, open it by pulling the toggle to the right. Remove the vial from the chamber, using gloves or the 6754 Extractor. At this point either close the lid to conserve LN or insert another vial and begin another grinding cycle.

6.5 Opening, Emptying, and Cleaning Freezer/Mill Vials

6.5.1 Opening a Vial

To open the small vial, slip the open end of the 6754 Extractor/Vial Opener over the flanged end-plug, align the pegs in the end plug with the slots in the Extractor, and turn the knob clockwise until the end plug is drawn out. If the end plug is drawn out within a millimeter or two of the end of the center cylinder and stops, rock the 6754 Extractor gently to dislodge the end plug. Always be careful that the vial does not fall and spill its contents.

If the Extractor/Vial Opener jams with the end plug part way out, let the vial warm up before removing the end plug. Forcing out the end plug can damage the Extractor or break the polycarbonate center section. The best way to prevent the Extractor from jamming is to make sure both the Extractor and the threaded end plugs are dry and clean before use.

If the Extractor/Vial Opener jams when being threaded into a cold end plug, it is probably due to water condensing and freezing on the extractor screw. The water freezes when it contacts a cold end plug. If this happens, make a habit of wiping off the screw with a paper towel before each use. Note that the end of the screw is tooled with an “X” cut to help remove any ice that forms on the end plug, but this is not always effective. Chilled vials can also be opened easily and quickly with the optional accessory 6756 Extractor for Small Freezer/Mill Vials.

On rare occasions a flanged end plug will stick in the vial when cold, even if the Extractor screw and end plug threads are dry and clean. If this happens do not force the end plug out, as the vial and/or the Extractor may become damaged. Allow the vial to warm up. The vial can be allowed to warm up gradually, wrapped in several layers of cloth or paper towels. Once the vial is warm, the stuck end plug can be drawn out by hand or with a pair of pliers. When using pliers to extract an end plug, rotate the end plug and pull gently, as if unscrewing a bottle-cap. Forcibly rocking the end plug from side to side can stress the polycarbonate tube and crack it.

CAUTION: Pressure can develop inside a Freezer/Mill vial as it is warming. As pressure builds, an end plug can pop out with force and the sample can be lost. For this reason handle vials with care, and wrap them in paper towel. It is best to open chilled vials immediately after removing them from the Freezer/Mill.

6.5.2 Emptying a Vial

As soon as the flanged end plug is removed from a cold vial, empty the contents of the vial into a suitable container, the quicker the better as condensation on a cold sample occurs rapidly. Often it is helpful to tap the closed end of the vial to release the ground sample. Remember that the impactor may slide out ahead of the contents or with them, and that the longer the sample is exposed to air, the more water it will acquire from condensation. Samples which were tacky, spongy, etc., at room temperature will also return to that state as they warm up, and may agglomerate.

6.5 Opening, Emptying, and Cleaning Freezer/Mill Vials (Cont'd)

The impactor will have to be separated from the sample and can be handled with gloved fingers, a strong magnet, tongs, or pliers. Tools without a good gripping surface are likely to slip off the impactor. 6870S Accessory Pack included a Magnetic Extractor (6791). This is a rod with a magnetic tip that can be used to remove the impactor from a vial before emptying the contents.

If some condensation on a cold sample is unacceptable, either wait for the sample vial to warm up before opening and emptying it, or open and empty a chilled vial in a glove box filled with dry nitrogen gas.

Small amounts of sample usually adhere to the vial's impactor, end plugs, and plastic cylinder. Brushing or scraping these surfaces of the vial can often recover this fraction of the sample. Again, speed is important to minimize condensation and other effects of warming.

If it is necessary to recover 100% of the sample, let the vial warm up and add some water or other liquid that will not affect the polycarbonate (see Section 6.5.3). Shake the vial, empty it onto some filter paper, and rinse again if necessary to recover the entire sample.

6.5.3 Cleaning the Vials

The Freezer/Mill vials may be superficially cleaned quickly and easily by placing them under running warm water. If the vial is cold a coating of ice will form on the steel parts, but will melt quickly as the water runs.

The plastic center cylinders for all vials, and the Poly-Vial end plugs and impactor capsules, are made of polycarbonate. ***While this polymer is very tough at low temperatures, it is sensitive to alcohol, acetone, and other organic solvents, and should be cleaned only with soap and water.*** A mild bleach solution will control organic contamination. Polycarbonate can be autoclaved, but this will weaken it.

Before re-using polycarbonate cylinders, ***always*** inspect them for cracks or other damage. They may last for dozens or hundreds of samples, but as soon as they begin to crack they should be discarded. Liquid nitrogen can enter through cracks and vaporize when vial is removed from Freezer/Mill. As the vial warms vaporized LN will build pressure and an end plug can pop out with force so the sample may be lost.

If sample adheres to the steel end plugs and impactor, they can be cleaned with water and soap or detergent, or with organic solvents. If they must be disinfected or cleaned of any organic residue, they can be washed with bleach or chemical cleaners or autoclaved, but should always be dried immediately after use. The steel parts in the 6751 and 6757 vials are made from 440C Stainless Steel, a magnetic stainless steel, which is corrosion-resistant but may rust to some extent if left in contact with water for too long. All stainless steel parts should be dried after washing.

6.5 Opening, Emptying, and Cleaning Freezer/Mill Vials (Cont'd)

The steel parts of the chromium-free 6771 vial can also be washed, disinfected, or autoclaved. **Do not wash with bleach or chemical cleaners.** Chromium-free steel is not rust-resistant and must always be dried immediately after washing. Store Cr-Free Vial parts in a sealed bag with a desiccant. Rust on steel Freezer/Mill parts can be removed by scrubbing them with steel wool or an abrasive cleanser. If rusting persists, store the parts in a sealed bag with a desiccant.

6.6 Checking the Liquid Nitrogen Level

Every time a vial is inserted into or removed from the Freezer/Mill, note the level of liquid nitrogen (LN) in the tub. The LN should be topped off when needed as a matter of routine. If the programmed grinding cycle includes more than twenty or thirty minutes of actual grinding time, the nitrogen level should be visually checked at about that point and more added if needed. A cumulative grinding time of more than thirty minutes per run is not recommended, as after that much grinding the LN level is close to the point where the LN sensor will shut down the mill. However, if the mill must be run for an extended time, and the LN sensor stops the grinding program, the mill can be refilled with LN and the grinding program resumed where it stopped.

7.0 RESOURCES

The Resources screen button is located on the Home screen (Figure 4). To access the Resources screen touch the Resources button. On the Resources screen, as seen in Figure 14, are additional buttons to recall the run history, technical support, accessories (e.g. vials, holders, etc.), and training information (e.g. how-to videos, operating manual). Located at the top right on the Resources screen is the Settings button shaped as a Gear Icon. At the bottom right on the Resources screen is the Home Icon button . Touching the Home Icon returns the user to the Home Screen (Figure 4).

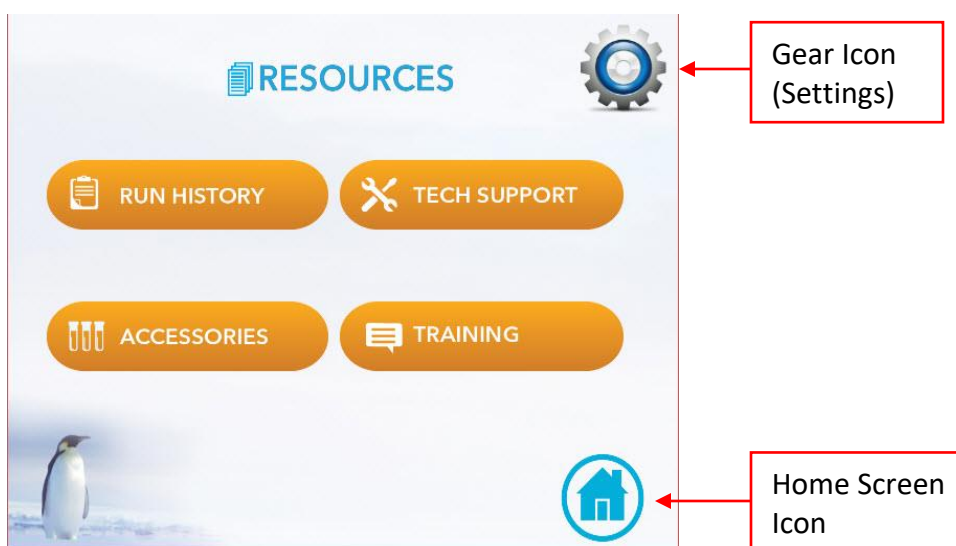

Figure 14 – Resources Screen

7.1 Run History

To recall the Run History touch the Run History button. The Date, Time, and Run Protocol data are stored on this screen, as shown in Figure 15. The run information can be exported to other computer devices via the USB Port located on the back of the Controller. To export run data touch the Export History button at the bottom right of the screen. To clear Run History or delete Run History permanently from data storage, touch the Clear History button at the bottom left of the screen. To return to the Resources screen touch the back arrow button at the top left of the screen.



The screenshot shows the 'RUN HISTORY' screen with a back arrow at the top left. The table below contains the following data:

| Date / Time | Pre | Run | Cool | Cyc | Rate | Auto | Dual | Complete |
|---------------------|-----|-----|------|-----|------|-------|-------|----------|
| 2015-11-28 18:35:45 | 1 | 2 | 1 | 4 | 10 | false | false | false |
| 2015-11-28 18:36:47 | 1 | 2 | 1 | 4 | 10 | false | false | false |
| 2015-11-28 18:37:13 | 4 | 3 | 2 | 5 | 11 | false | false | false |
| 2015-11-29 16:52:19 | 1 | 2 | 1 | 4 | 10 | false | false | false |
| 2015-11-29 16:52:25 | 1 | 2 | 1 | 4 | 10 | false | false | false |
| 2015-11-29 16:52:30 | 1 | 2 | 1 | 4 | 10 | false | false | false |
| 2015-11-29 17:09:23 | 1 | 2 | 1 | 4 | 10 | false | false | false |
| 2015-11-29 17:09:25 | 1 | 2 | 1 | 4 | 10 | false | false | false |
| 2015-11-29 17:09:27 | 1 | 2 | 1 | 4 | 10 | false | false | false |
| 2015-12-01 20:55:55 | 1 | 2 | 1 | 4 | 10 | false | false | false |

At the bottom of the screen, there is a penguin icon on the left, a 'CLEAR HISTORY' button with a back arrow, and an 'EXPORT HISTORY' button with a USB icon.

Figure 15 – Run History Screen

7.2 Accessories [Electronic Version] – (Available for purchase at additional cost)

To enter the Accessories Screen touch the Accessories button. In the Accessories Screen items are grouped into separate categories (e.g. Grinding Vials, Vial Racks, Extractors), as shown in Figure 16. To open any of the categories listed touch the **+** button to the right of the screen. For example, pressing the **+** button for the Extractors displays the screen for items available in this category. (Figure 17)

To close or minimize the items displayed screen, touch the **-** button top-right of the screen. To return to Resources screen touch the back arrow button at the top left of the screen.

7.2 Accessories [Electronic Version]

Note, in the Accessories Screen items are grouped into separate categories (e.g. Grinding Vials, Vial Racks, and Extractors).

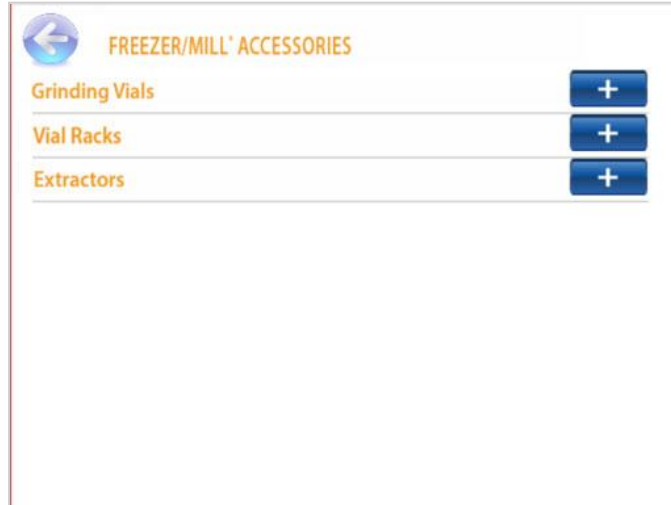

Figure 16 – Accessories screen

Note, the Extractors displays the screen for items available in this category.

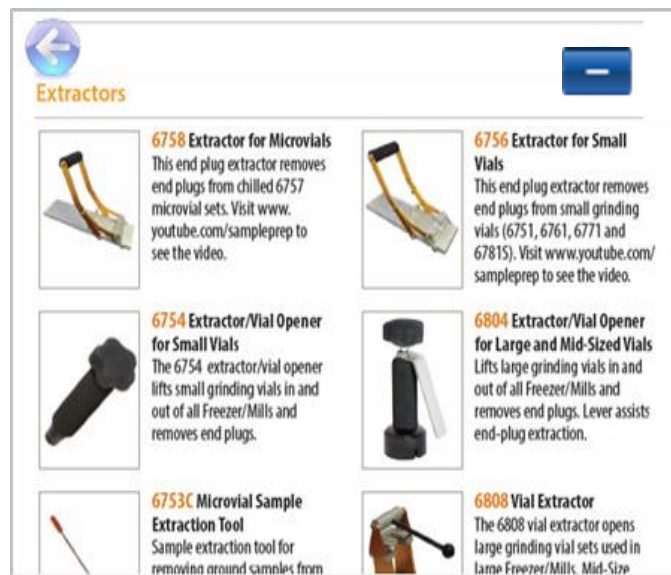

Figure 17 – Extractor Accessories

7.3 Training

To access the Training screen touch the Training button on the Resources screen. In the Training screen the operating manual, instructions and how-to-use videos are listed. To open any of the categories listed on the screen touch the button name, as displayed in Figure 18. To return to Resources screen touch the back arrow button at the top left of the screen.

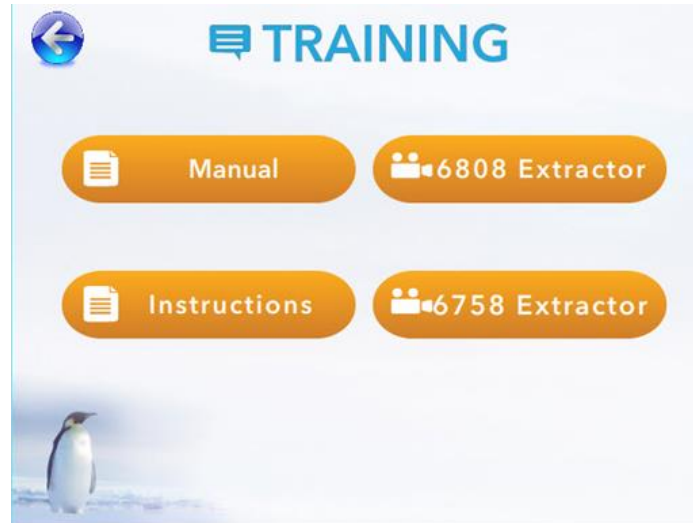

Figure 18 - Training Screen

7.4 System Settings

To access the Settings screen touch the Gear Icon. The System can be upgraded, the time display changed from 12-hour to 24-hour, and Time and Date can be entered or changed, as shown in Figure 19. Touch window to change settings then touch the SET button to lock in the figure. A pop-up window opens confirming Time or Date resets. To return to Resources Screen touch the back arrow button at the top left of the screen.

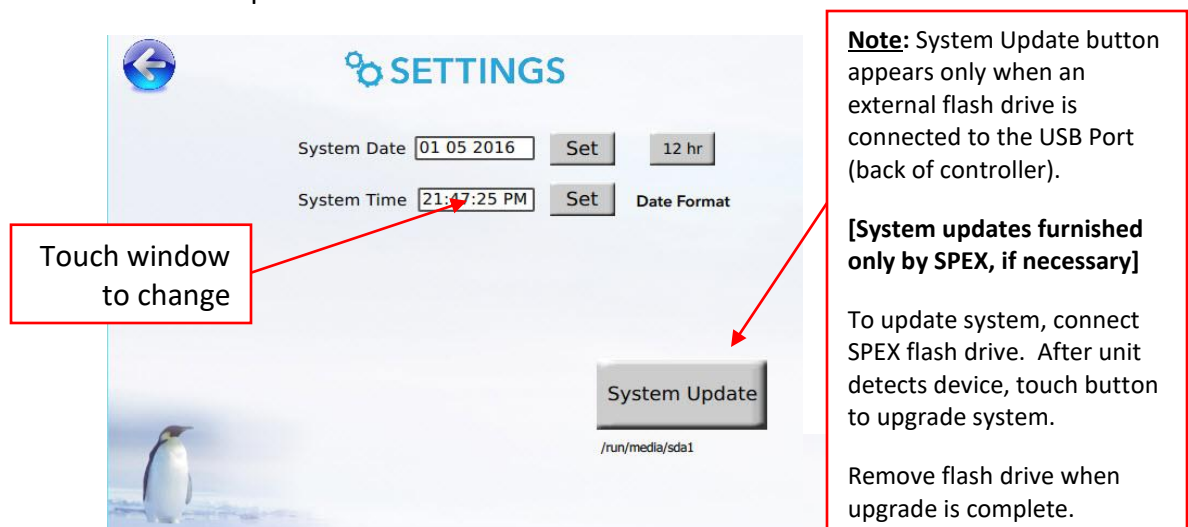

Figure 19 – Settings Screen

7.5 Technical Support

To access the Technical Support screen touch the Tech Support button on the Resources screen. SPEX contact information for the USA Headquarters and Europe Sales Office is listed on this screen (Figure 20). To return to Resources screen touch the back arrow button at the top left of the screen.



Figure 20 - Technical Support Screen

8.0 MAINTENANCE

The 6775 Freezer/Mill has been designed to provide trouble-free operation over a long period of time. To assure proper performance it is very important to keep the unit clean. When the Freezer/Mill is at room temperature, any spilled powders or liquids should be wiped up immediately. The internal tub should be wiped clean with a damp cotton cloth after every use.

This should prevent the buildup of any powders, mold/mildew, or other residue over the life of the unit. If any samples, powder materials, or liquids are spilled inside the unit during a sample run, wait until Freezer/Mill is finished for the day, the liquid nitrogen has evaporated, and the mill has warmed up to room temperature before attempting to clean it. Once the unit has attained room temperature, wipe down the unit as indicated previously. After every period of use, the mill will become wet with condensation due to the Freezer/Mill picking up moisture from air when it is cold.

To maintain the exterior of the unit, first disconnect the Freezer/Mill from its electrical source. Then lightly spray with a mild window cleaner or similar product and wipe unit down. If the 6775 Freezer/Mill requires service, please call SPEX SamplePrep Customer Service for assistance.

8.1 Changing the Fuses

If the Freezer/Mill will not operate when the start button is pressed, it is possible that one or both fuses may have blown. To access the fuses, first remove the power cord from the back of the Freezer/Mill. Then open the door on the fuse compartment by gently prying it open at the top and flipping it down, as shown in Figure 21. Use a small screwdriver to gently pry the red fuse holder out of the compartment, as shown below. Remove the fuses and check them using a continuity tester. If either fuse is blown or defective, replace both with 3AG 5-amp, 250V slow-blow fuses. Position the fuse holder such that the appropriate operating voltage appears on top. Return the fuse holder to the fuse compartment and close the access door. Check the window of the fuse compartment to make sure that it shows the appropriate voltage. If not, the fuse holder is upside down and must be turned around before attempting to operate the Freezer/Mill.

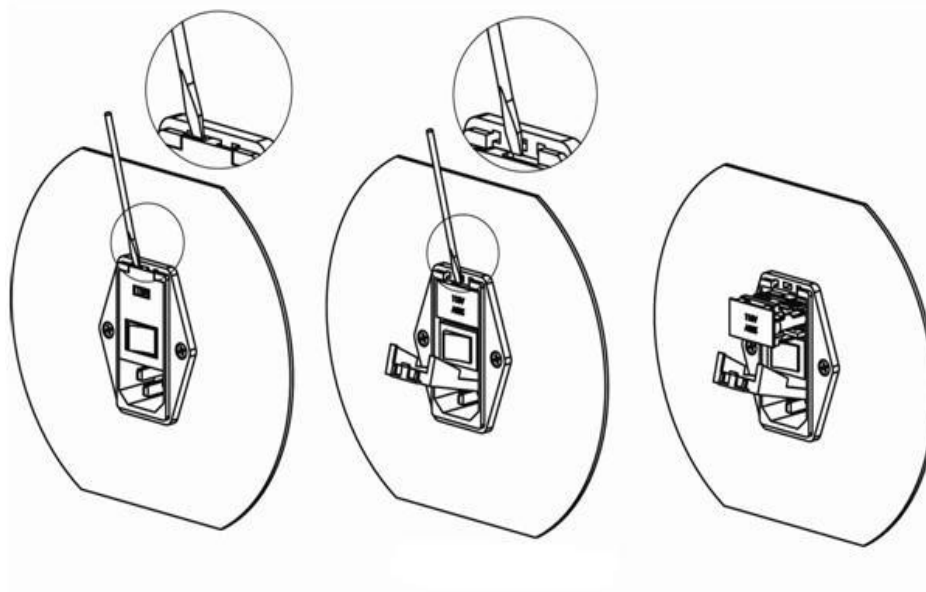

Figure 21 – Fuse Compartment

9.0 TROUBLE-SHOOTING GUIDE

| PROBLEM | POSSIBLE CAUSE | POSSIBLE SOLUTION |
|---|--|--|
| The unit does not turn on. | No current. | Make sure power cord is plugged into outlet and inlet. |
| | No current. | Check outlet for power cord and correct as required. |
| | Power switch not turned on. | Press power switch to ON position. |
| | Blown fuse. | Replace fuses. |
| | Blows fuses repeatedly. | Electrical short. Contact SPEX SamplePrep and return for repair. |
| Screen displays "LID UP". | Safety interlock switch not engaged. | Close the lid and latch. |
| | Lid is not closed completely. | Push the lid closed and latch into place. |
| Screen displays "LN LEVEL LOW". | Liquid nitrogen sensor detects inadequate liquid nitrogen level. | Pour more liquid nitrogen into the tub. |
| Coil gets very warm. | Low liquid nitrogen levels. | Pour more liquid nitrogen into the tub. |
| Impactor doesn't shuttle back and forth. | Water in vial has frozen impactor. | Remove vial and replace vial and contents with a dry unit or RAP ends of the vial on counter to free impactor. |
| | Impactor is magnetized. | Remove impactor, turn end-for-end, or demagnetize impactor and re-insert. |
| | Too much sample is in the vial or sample pieces are too large | Remove some sample from the vial and start again |
| Flanged End Plug doesn't come off cold vial. | End plug/tube joint too tight when very cold. | Allow vial to warm up. |
| Blunt end plug doesn't come off room-temperature vial. | Hard to grip | Warm vial under warm water. Use wide-jaw pliers if necessary. |
| 6754 Extractor jams. | Water on extractor screws or bell. | Dry extractor before each use. |
| | Ice in threaded hole in end plug. | Dry end plug thoroughly before using. |
| Plastic center cylinder cracks. | Cylinder cleaned with alcohol or other organic solvent. | Use bleach, detergent, and water to clean cylinders. |
| | Vial assembled when chilled. | Never force end plugs into a cylinder. |
| | Sample pieces acts as wedge. | Reduce size of sample pieces. Make sure there are no sample particles on cylinder ends. |

10.0 WARRANTY

SPEX SamplePrep LLC guarantees its products and new equipment against defects in materials or workmanship for one year from the date of original shipment. Repairs, replacements, or parts are guaranteed for 30 days or for the remaining original warranty period (whichever is greater) for the item that was repaired or replaced. Items not produced by SPEX SamplePrep LLC carry the manufacturer's warranty only. 6775 Freezer/Mill wear parts include the coil.

The customer pays return freight for warranty claims. If the warranty claim is valid, SPEX will pay return freight to the customer. However, SPEX SamplePrep reserves the right to judge whether a malfunction during the warranty period is due to defects in materials or workmanship, or to wear, negligence, or misuse.

10.1 Product Specifications

Every effort has been made to provide complete and accurate product operating information in this manual. However, since specifications are subject to change without notice, changes may be made from time to time to improve the performance, reliability, and function of the product. Therefore, slight changes that are not reflected in the current illustrations should be considered minor and inconsequential for the purposes of this operating manual.

10.2 To Arrange a Return Shipment

We want you to be happy with whatever you purchase from SPEX SamplePrep. Please bring any problem to our attention, but please do not return any item before contacting us for a Return Authorization Number and instructions. Unauthorized returns will be refused. Cost for all return transportation is the responsibility of the customer. Credit for returned merchandise will be issued only after goods have been received and inspected. Returned goods are subject to a 25% restocking charge up to a maximum of \$200.00.

11.0 INSTRUMENT DISPOSAL

In accordance to the EU Directive 2012/19/EU covering Waste Electrical and Electronic Equipment, all equipment with the disposal symbol must not be disposed of with general waste. (See Figure 1)

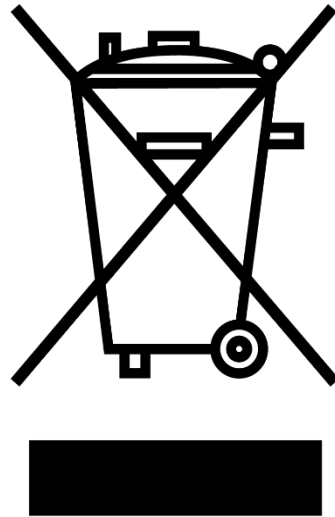

Disposal Label is located on the back of unit.

Figure 22 – Disposal Symbol

Throughout the European Community, guidelines regarding disposal regulations may vary from territory to territory. Please contact the national legislation or local authority for more information on proper disposal of all equipment with this symbol.

12.0 CONTACT US

Within the United States, write, telephone, or e-mail us at:

SPEX SamplePrep LLC
65 Liberty St.
Metuchen, New Jersey 08840

Tel.: 855-GET SPEX (438-7739), Ext. 465 or 732-623-0465

Fax: 732-906-2492

Website: www.spexsampleprep.com

E-mail: sampleprep@spex.com

In Europe, please contact our European Sales Office at:

SPEX Europe
2 Dalston Gardens
Stanmore
Middlesex HA7 1BQ
United Kingdom

Tel: +44 (0) 208 204 6656

Fax: +44 (0) 208 204 6654

Website: www.spexeurope.com

E-mail: spexeurope@spex.com

Outside the United States and Europe, contact the SPEX SamplePrep representative from whom you purchased your equipment. A list of our current representatives is on our website, www.spexsampleprep.com.